

## Shapes

Radial  
22.5"

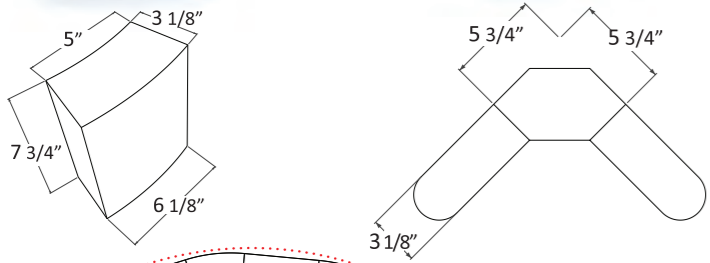

Veer  
90°

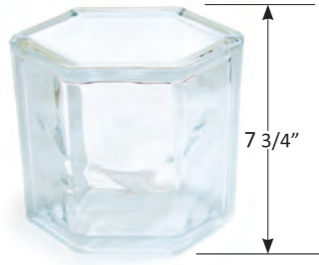

## Radius Walls

Mixed block radius layouts do not follow a perfect radius. It is recommended to use the Layout Cards to have as an exact template.

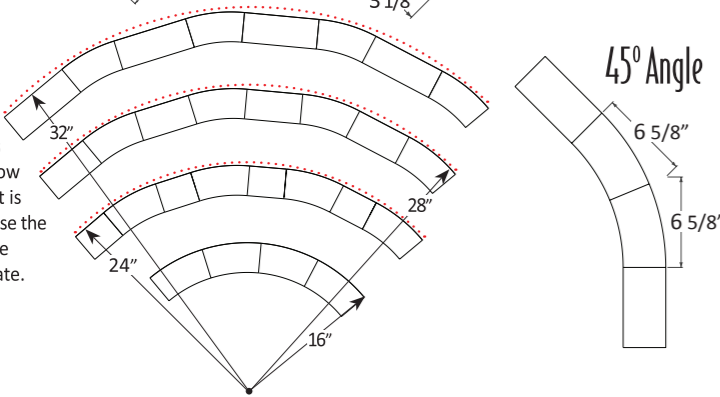

3" THIN Main Line (3-1/8" ACTUAL THICKNESS)								spring 2012	*available Fall 2012
SIZES - NOMINAL IN INCHES									
PATTERNS	4X8X3	6X6X3	6X8X3	8X8X3	Radial 22.5 Radius Block 6" X 8"	Veer 90° Corner 6" X 8"	END BLOCK 8X8X3	Double END BLOCK 8X8X3	END BLOCK 6X8X3
WAVE	X	X	X	X	X	X	X	X*	X*
CLEAR	X	X	X	X	X	X	X	X*	X*
ICEBERG	X	X	X	X					
PRISTAL	X	X	X	X					
BROMO				X					
BUBBLES				X					
DIAMOND				X					
OCEAN VIEW				X					
QUADRA				X					

4" THICK SERIES (3-7/8" ACTUAL THICKNESS)							
SIZES - NOMINAL IN INCHES							
PATTERNS	4X8X4	6X6X4	6X8X4	8X8X4	12X12X4	END BLOCK 8X8X4	DOUBLE END BLOCK 8X8X4
WAVE	X	X	X	X	X	X	X
CLEAR	X	X	X	X	X	X	X
ICEBERG	X	X	X	X	X	X	X
WAVE THICKFACE (60 min)			X				
QUADRA THICKFACE (60 min)			X				

## Finishes

End Block



Double End Block



## Patterns

Privacy Scale 0-5

### Wave

Privacy Level #1



### Clear

Privacy Level #0



### Quadra

Privacy Level #4



### Bubble

Privacy Level #3



### Ice Berg

Privacy Level #5



### Diamond

Privacy Level #2

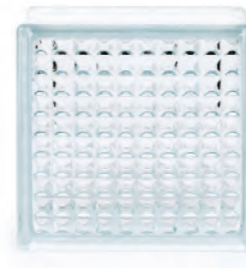

### Pristal

Privacy Level #4

## Performance Chart

	NOMINAL			ACTUAL			COMPRESSIVE STRENGTH (PSI)	WEIGHT (LBS)	SHADING COEFFICIENT	LIGHT TRANSMISSION	SOUND LEVEL LOSS (STC)	R VALUE /BTU
	LENGTH	HEIGHT	THICKNESS	LENGTH	HEIGHT	THICKNESS						
<b>WAVE</b>												
4" THICK SERIES	8	8	4	7-3/4	7-3/4	3-7/8	400-700	5.9	0.655	60	41	1.95 / .51
4" THICK SERIES	6	8	4	5-3/4	7-3/4	3-7/8	400-700	4.5	0.655	65	35	1.75 / .55
4" THICK SERIES	6	6	4	5-3/4	5-3/4	3-7/8	400-700	4.0	0.655	65	35	1.75 / .55
4" THICK SERIES	4	8	4	3-3/4	7-3/4	3-7/8	400-700	3.5	0.655	65	35	1.75 / .55
<b>WAVE</b>												
4" THICK FACE (60 MIN)	8	8	4	7-3/4	7-3/4	3-7/8	400-700	11.0	0.655	60	50	1.96 / .51
<b>WAVE, PRISTAL, ICEBERG</b>												
3" THIN SERIES	8	8	3	7-3/4	7-3/4	3-1/8	400-700	5.3	0.655	65	35	1.95 / .51
3" THIN SERIES	6	8	3	5-3/4	7-3/4	3-1/8	400-700	4.4	0.655	65	35	1.75 / .51
3" THIN SERIES	6	6	3	5-3/4	5-3/4	3-1/8	400-700	3.2	0.655	65	35	1.75 / .55
3" THIN SERIES	4	8	3	3-3/4	7-3/4	3-1/8	400-700	3.0	0.655	65	35	1.75 / .55
<b>QUADRA</b>												
3" THIN SERIES	8	8	3	7-3/4	7-3/4	3-1/8	400-700	5.3	0.655	65	35	1.75 / .55

## Maximum Panel Dimensions

PERIMETER SUPPORT METHOD	THICK SERIES AREA (SQ.FT.)	THIN SERIES AREA (SQ.FT.)
<b>EXTERIOR</b>		
CHANNEL TYPE RESTRAINT	144	85
PANEL ANCHORS	144	85
CHANNELS WITH PANEL ANCHORS WITH INTERMEDIATE STIFFENER	250	150
<b>INTERIOR</b>		
CHANNEL TYPE RESTRAINT	250	150
PANEL ANCHORS	250	150

\* Uniform Building Code (UBC) limits height and width to 15 feet.

## Wind Load Resistance

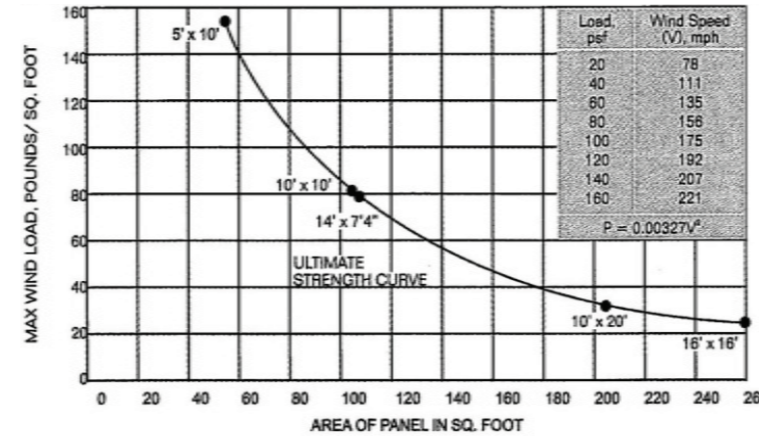

### HOW TO USE WIND LOAD CHART

Example: If panel desired is 140 sq.ft., review table and you will see the maximum wind load is approximately 52 psf. Maximum exterior panel sizes are based on a design wind load of 20 lbs. per sq.ft. with a 2.7 safety factor.



**MULIA**  
GLASSBLOCK  
www.mulia.com  
(562) 345-2788

Distributed By

**BLOCKPRO**  
GLASS BLOCK & SYSTEMS  
www.block-pro.com

## BlockPro Dealer



# BLOCKPRO

## GLASS BLOCK & SYSTEMS

## Better Value

- Light Weight
- Brighter
- More Flexible Design
- New patterns
- Simplified Installation



Clearly  
Thin  
Is  
In

Crisp  
New  
Color  
With A  
Clean  
New  
Look

# Tub & Shower Replacement

This ready to install kit installs in just a few hours and beautifully transforms your common tub or shower into a custom door free shower. Includes Acrylic Pan, Modular Glass Block Walls, Ready-4-Tile Wallboard, & all accessories needed for installation.

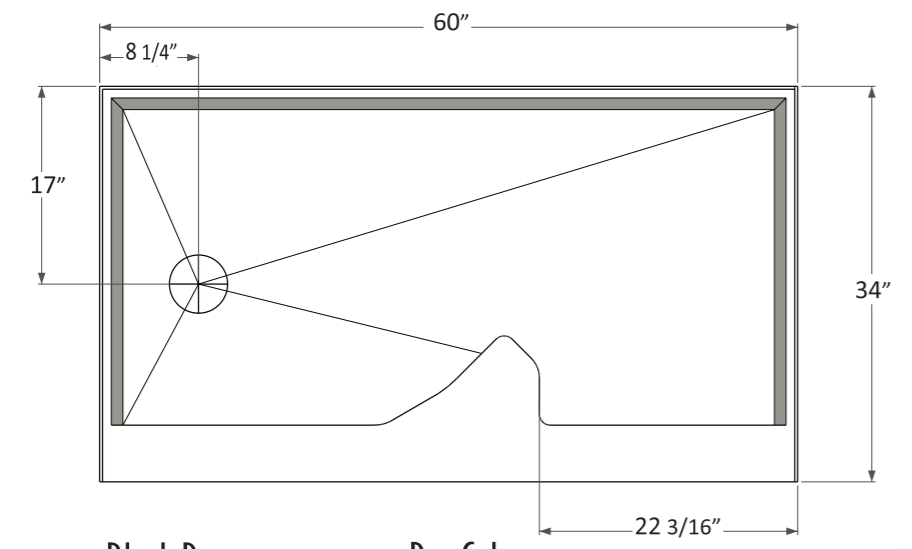
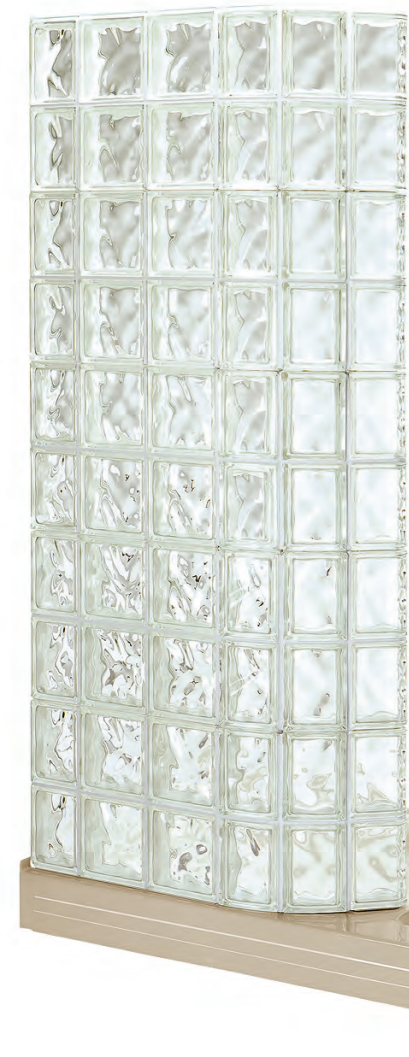

**Block Patterns**

Wave Clear Biscuit White



# Style Caps



Cool Grey Snow White Biscuit

4" Thick Line Caps

	4"	3 9/16" x 3 11/16"
	6"	3 9/16" x 5 11/16"
	8"	3 9/16" x 7 11/16"
	12"	3 9/16" x 11 3/4"

3" Thin Line Caps

	4"	2 13/16 x 3 11/16
	6"	2 13/16 x 5 11/16
	8"	2 13/16 x 7 11/16
	End block 8" Thin line	2 13/16 x 5 13/16
	Veer Thin line	4 1/16 x 7 19/32
	Radial Thin line	2 13/16 x 5 13/16

# Basement Windows



# Bathroom Windows



# Side Lights



Bar Base

# Vinyl Wrap Windows



## Details

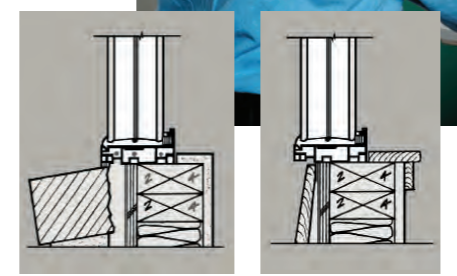

Vinyl Wrapped Glass Block windows are made to your specification and are ready to nail in place for a lifetime of performance.

## CUSTOM COLOR VINYL COATINGS

A wide variety of custom colors available

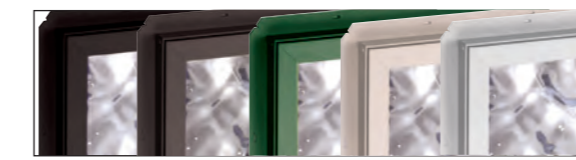

## Rough Opening Chart

Based on Using 8"x8" Glass Block Units  
Custom 3" & 4" Thick

Number of Blocks	Rough Opening
1	10 1/8"
2	18"
3	25 7/8"
4	33 3/4"
5	41 5/8"
6	49 1/2"
7	57 3/8"
8	65 1/4"
9	73 1/8"
10	81"



# Layout Cards



Layout Cards simply snap together to represent the exact length and shape of the assembled Glass Block design to act as an instant template for any design.



# Stack & Grout



Complete Install Kits customized to your application. Simply adhere the vinyl spacers to the Glass Blocks with the adhesive provided that will perfectly space and align the units then finish the joints with the high strength water repelling and stain resistant grout.

